

# Designer as Intern First, *a series of forms and questionnaires*

design studio

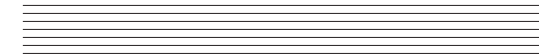

intern



mentor

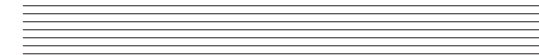

POWERED BY LABOR SPORTS

\*\*for official use only

## IMMATERIAL LABOR

academic term |i(m)mə tɪrēəl| + |ləbər|

labor that produces the informational and cultural content of the commodity.

## INTERN

noun |'ɪn.tərn|

a student or trainee who works, sometimes without pay, at a trade or occupation in order to gain work experience.

verb |ɪn.tərn|

[ with obj. ] confine (someone) as a prisoner, esp. for political or military reasons.

## MENTOR

noun |'men.tɔr, -tər|

an experienced person in a company, college, or school who trains and counsels new employees or students.

verb

[ with obj. ] advise or train (someone, esp. a younger colleague)

## INTERFACE

noun |ɪn(t)əfās|

a point where two systems, subjects, organizations, etc., meet and interact.

## GRAPHIC DESIGN

noun |ɡrafɪk də zɪn, dē zɪn|

the art or profession of using design elements (as typography and images) to convey information or create an effect; also : a product of this art.

**DESIGN INTERN PROFILE**

**official bio**

full name		nickname(s)	
**please print with a pen	country(ies) of origin	language(s) spoken	
	talent(s)		
	age	zodiac	

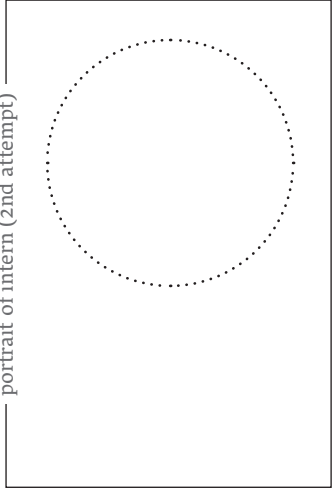
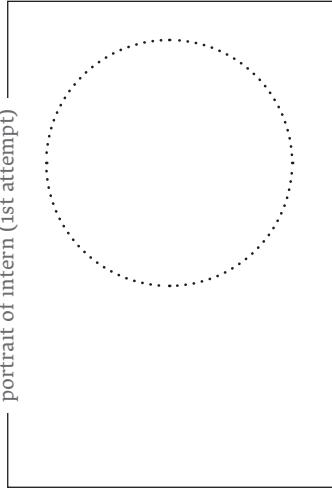

**pre-studio questionnaire**

good design can save the world?	<input type="checkbox"/> <input type="checkbox"/>	what do you want to learn from this internship?
the quick brown fox jumps over the lazy dog?	<input type="checkbox"/> <input type="checkbox"/>	
design is art?	<input type="checkbox"/> <input type="checkbox"/>	
so... dutch design?	<input type="checkbox"/> <input type="checkbox"/>	
what is your go-to font?	<input type="checkbox"/>	
do you use hot corners?	<input type="checkbox"/> <input type="checkbox"/>	
which version of DIN are you on?	<input type="checkbox"/>	
what is graphic design?		

**post-studio questionnaire**

good design can ruin the world?	<input type="checkbox"/> <input type="checkbox"/>	what do you want to learn from this internship?
dafont is a legit resource?	<input type="checkbox"/> <input type="checkbox"/>	
art is design?	<input type="checkbox"/> <input type="checkbox"/>	
so... memes?	<input type="checkbox"/> <input type="checkbox"/>	
how big is your font collection?	<input type="checkbox"/>	
designer as ...	<input type="checkbox"/>	
the post critical is the most critical?	<input type="checkbox"/> <input type="checkbox"/>	
what kind of graphic designer are you now?		

**SPACE FOR LOGOS**

monthly objective	
resources	notes

month  year 20

week no.	objective	pass?	evaluation
	property of luthca design core	<i>y</i> <input type="checkbox"/>	
		<i>n</i> <input type="checkbox"/>	
		<i>y</i> <input type="checkbox"/>	
		<i>n</i> <input type="checkbox"/>	
		<i>y</i> <input type="checkbox"/>	
		<i>n</i> <input type="checkbox"/>	
		<i>y</i> <input type="checkbox"/>	
		<i>n</i> <input type="checkbox"/>	
		<i>y</i> <input type="checkbox"/>	
		<i>n</i> <input type="checkbox"/>	

\*\* for official use only

met expectations?	<input type="checkbox"/> <input type="checkbox"/>	final review
exceeded expectations?	<input type="checkbox"/> <input type="checkbox"/>	
broke a sweat?	<input type="checkbox"/> <input type="checkbox"/>	
no. of complaints	<input type="text"/>	

signature of intern \_\_\_\_\_ date \_\_\_\_\_

\_\_\_\_\_

\_\_\_\_\_

signature of mentor \_\_\_\_\_ date \_\_\_\_\_

\_\_\_\_\_

\_\_\_\_\_



monthly objective	
resources	notes

month  year 20

week no.	objective	pass?	evaluation
	property of luthca design core	<i>y</i> <input type="checkbox"/>	
		<i>n</i> <input type="checkbox"/>	
		<i>y</i> <input type="checkbox"/>	
		<i>n</i> <input type="checkbox"/>	
		<i>y</i> <input type="checkbox"/>	
		<i>n</i> <input type="checkbox"/>	
		<i>y</i> <input type="checkbox"/>	
		<i>n</i> <input type="checkbox"/>	
		<i>y</i> <input type="checkbox"/>	
		<i>n</i> <input type="checkbox"/>	

\*\* for official use only

met expectations?	<input type="checkbox"/> <input type="checkbox"/>	final review
exceeded expectations?	<input type="checkbox"/> <input type="checkbox"/>	
broke a sweat?	<input type="checkbox"/> <input type="checkbox"/>	
no. of complaints	<input type="checkbox"/>	

signature of intern \_\_\_\_\_ date \_\_\_\_\_

\_\_\_\_\_

\_\_\_\_\_

signature of mentor \_\_\_\_\_ date \_\_\_\_\_

\_\_\_\_\_

\_\_\_\_\_

REFERENCE

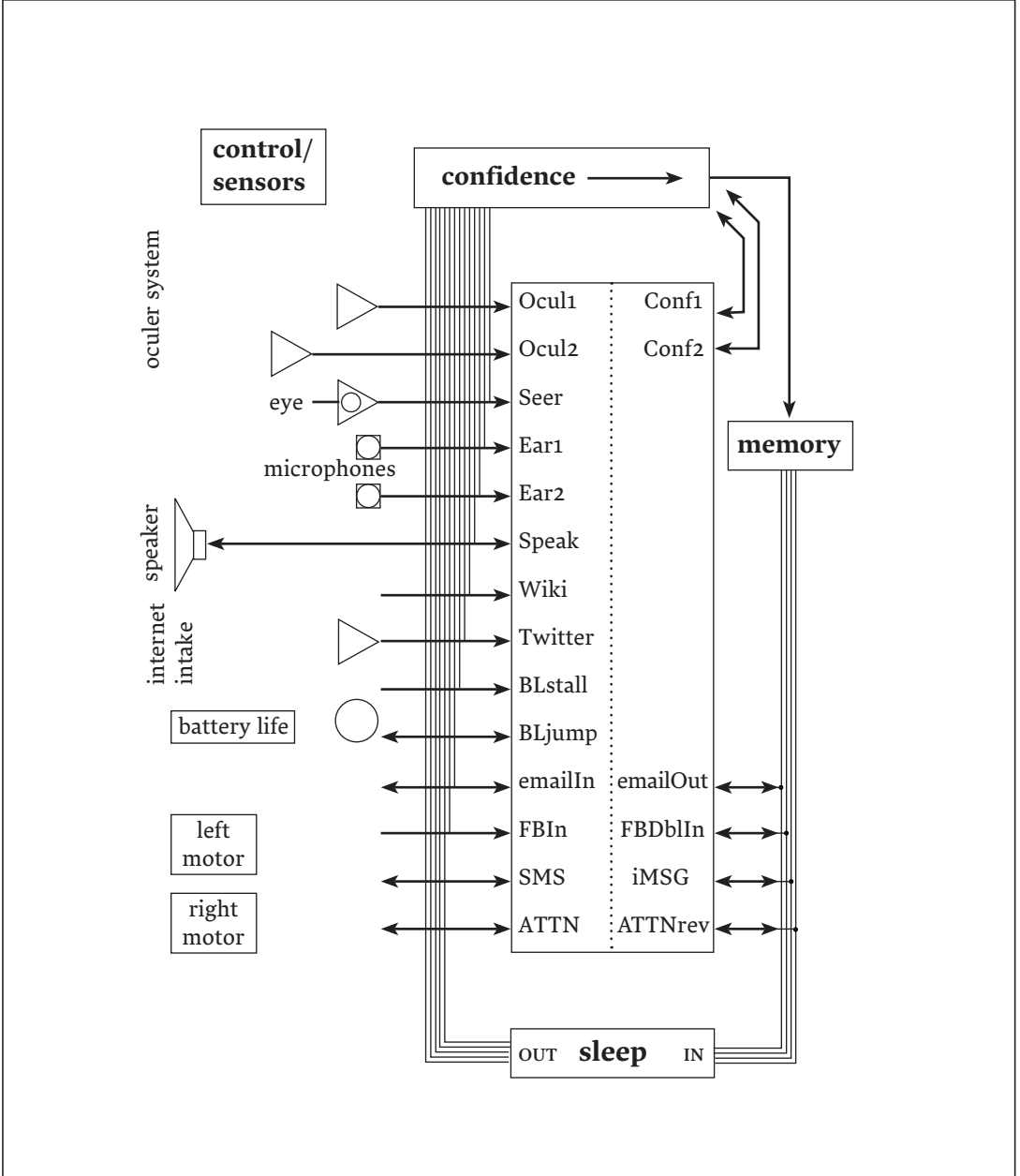

fig. 1 the Intern Brain

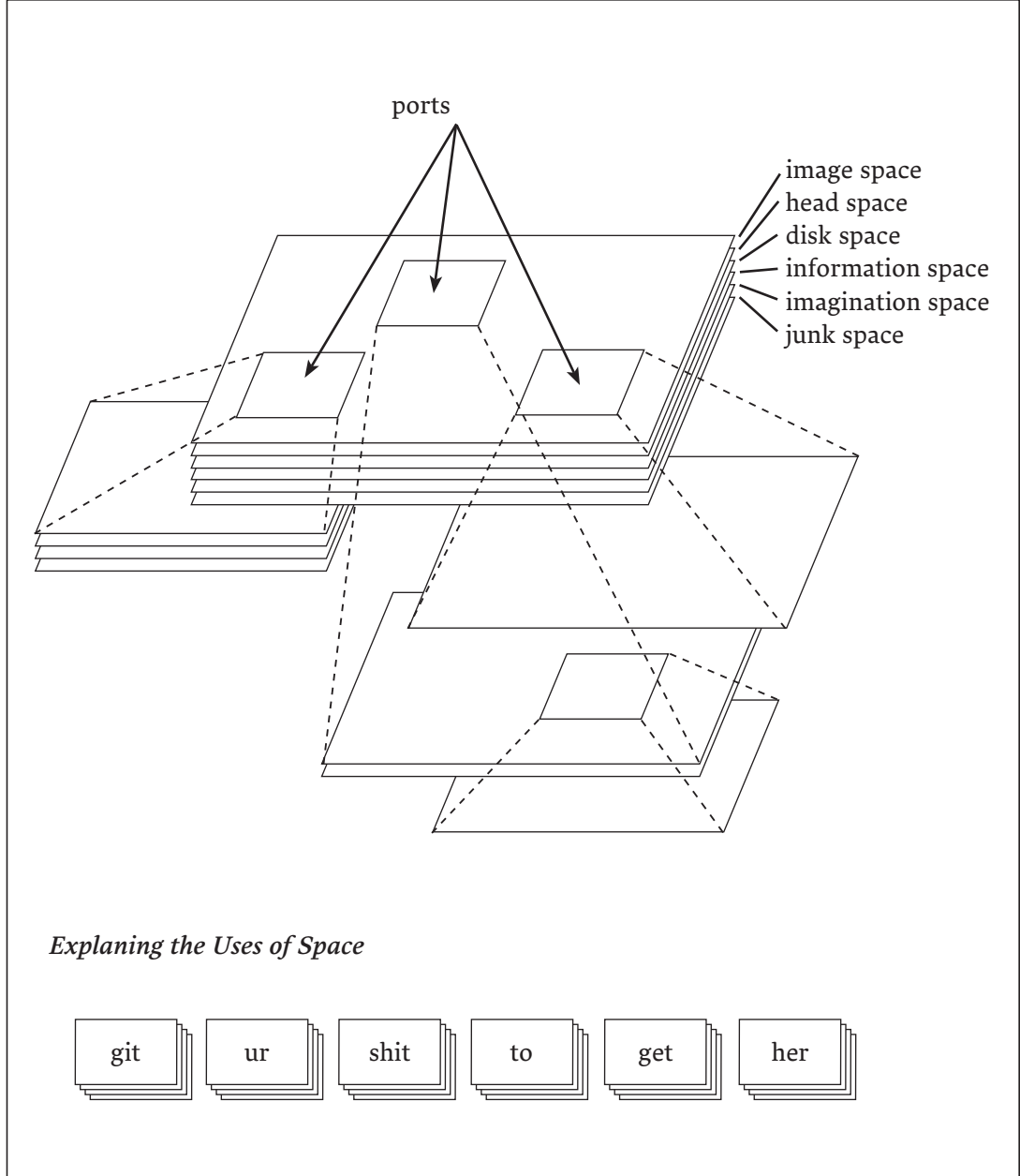

fig. 2 the Use of Space as it Pertains to the Designer

monthly objective	
resources	notes

month  year 20

week no.	objective	pass?	evaluation
	property of luthca design core	<i>y</i> <input type="checkbox"/>	
		<i>n</i> <input type="checkbox"/>	
		<i>y</i> <input type="checkbox"/>	
		<i>n</i> <input type="checkbox"/>	
		<i>y</i> <input type="checkbox"/>	
		<i>n</i> <input type="checkbox"/>	
		<i>y</i> <input type="checkbox"/>	
		<i>n</i> <input type="checkbox"/>	
		<i>y</i> <input type="checkbox"/>	
		<i>n</i> <input type="checkbox"/>	

\*\* for official use only

met expectations?	<input type="checkbox"/>	final review
exceeded expectations?	<input type="checkbox"/>	
broke a sweat?	<input type="checkbox"/>	
no. of complaints	<input type="checkbox"/>	

signature of intern \_\_\_\_\_ date \_\_\_\_\_

\_\_\_\_\_

\_\_\_\_\_

signature of mentor \_\_\_\_\_ date \_\_\_\_\_

\_\_\_\_\_

\_\_\_\_\_

REFERENCE / CONTEXT

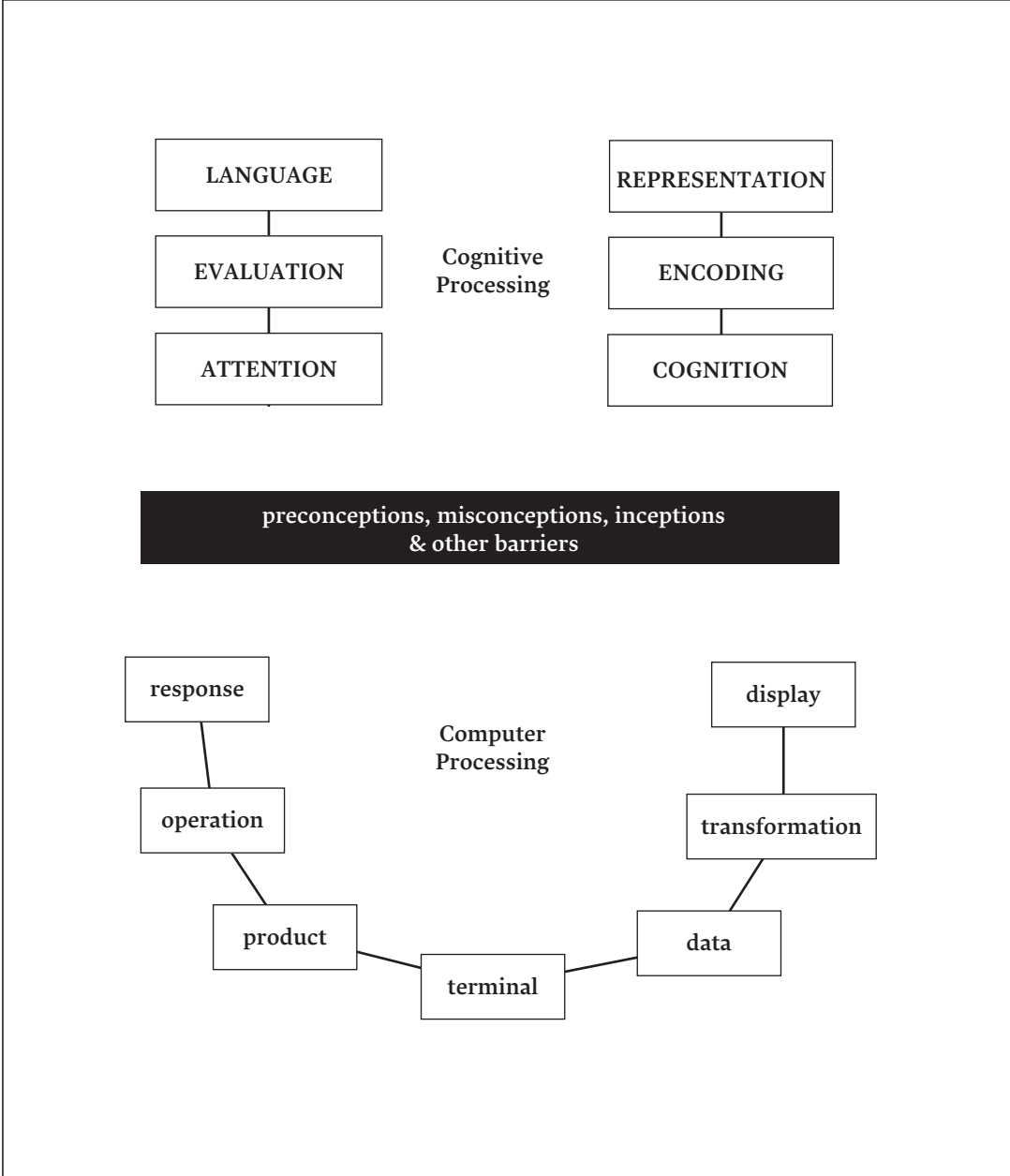

fig. 3 the Intern/Computer Interface

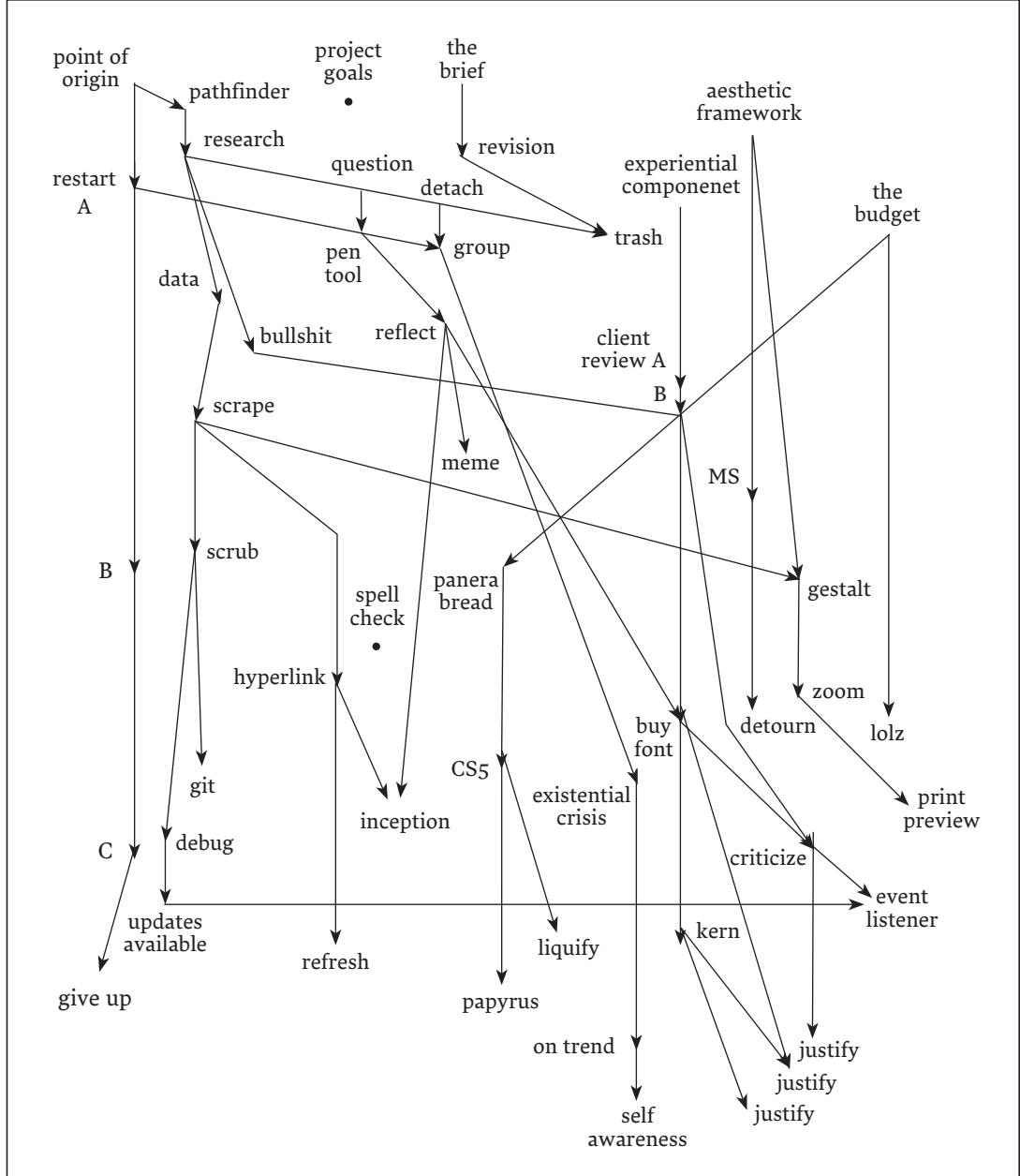

fig. 4 Design as the Machine of Many Probable Outcomes